

ASSEMBLY
PLANTING
STARTING

AeroGarden®

Simple Steps

To Get Your
AeroGarden® Classic
Up and Growing

Quick Start Guide

KEEP THIS GUIDE!

N. American Model #s:
100710-BLK; 100710-WHT; 100710-SLR
Input Voltage: 115V, 60Hz, 1.5A

EU & Australia Model #s:
200710-BLK; 200710-WHT; 200710-BKG; 200710-WTG;
500710-BLK; 500710-WHT; 500710-SLR
Input Voltage: 220-240V, 50Hz, 0.75A

Date Code:

IMPORTANT SAFETY INSTRUCTIONS

(SAVE THESE INSTRUCTIONS)

When using this AeroGarden electrical furnishing, basic precautions should always be followed, including the following:

Read all instructions before using this AeroGarden furnishing.

1. To reduce the risk of electric shock, the AeroGarden has a specific plug. Do not change plug in any way.

DANGER – to reduce risk of electric shock:

2. Always unplug AeroGarden from electrical outlet before cleaning or changing Grow Bulbs (light bulbs).

WARNING – to reduce risk of burns, fire, electric shock, or injury to persons:

3. Unplug AeroGarden from outlet before putting on or taking off parts.
4. Close supervision is necessary when AeroGarden is used by or near children, invalids, or disabled persons.
5. Use AeroGarden only for its intended use as described in the instructions. Do not use attachments not recommended by manufacturer.
6. Never operate AeroGarden if it has a damaged cord or plug, if it is not working properly, if it has been dropped and damaged, or if it has been dropped in water. If any of these conditions occur/exist, contact www.aerogardensupport.com or your country's local distributor for instructions.
7. Keep cord away from heated surfaces.
8. Never operate furnishing with air openings blocked. Keep air openings free of lint, hair, and the like.
9. Never drop or insert any object into any electrical openings.
10. Do not use outdoors.
11. Do not operate where aerosol (spray) products are being used or where oxygen is being administered.
12. Do not touch moving parts or hot parts such as pumps, bulbs, reflective surfaces, and the like.
13. To disconnect, remove plug from outlet.
14. Do not place or submerge base, cord, plug, or lamp hood in water or other liquid to clean it.
15. Do not allow water to contact hot light bulbs.
16. Use only approved and supplied parts and accessories. Use only lamp model 100629 (N. America) or 200629 (Europe & Australia) Grow Bulbs with this AeroGarden model. Use of any other kind of accessory is not recommended. Replacement parts can be ordered from www.aerogardensupport.com or from your retailer.
17. Do not use AeroGarden for other than intended purpose.
18. This product is intended for household and residential use only. This product is not approved for commercial applications.
19. Read and follow all important notices on the AeroGarden and in the accompanying literature.
20. If supply cord is damaged, it must be replaced by manufacturer, its service agent, or similarly qualified technician in order to avoid a hazard.
21. Electrical wiring must be in accordance with local regulations.
22. This appliance is not intended for use by persons (including children) with reduced physical, sensory or mental capabilities, or lack of experience and knowledge, unless they have been given supervision or instruction concerning use of appliance by a person responsible for their safety.
23. Children should be supervised to ensure they do not play with the appliance.

SAVE THESE INSTRUCTIONS

1 Quick Start Assembly (No tools required)

A Unpack Your AeroGarden

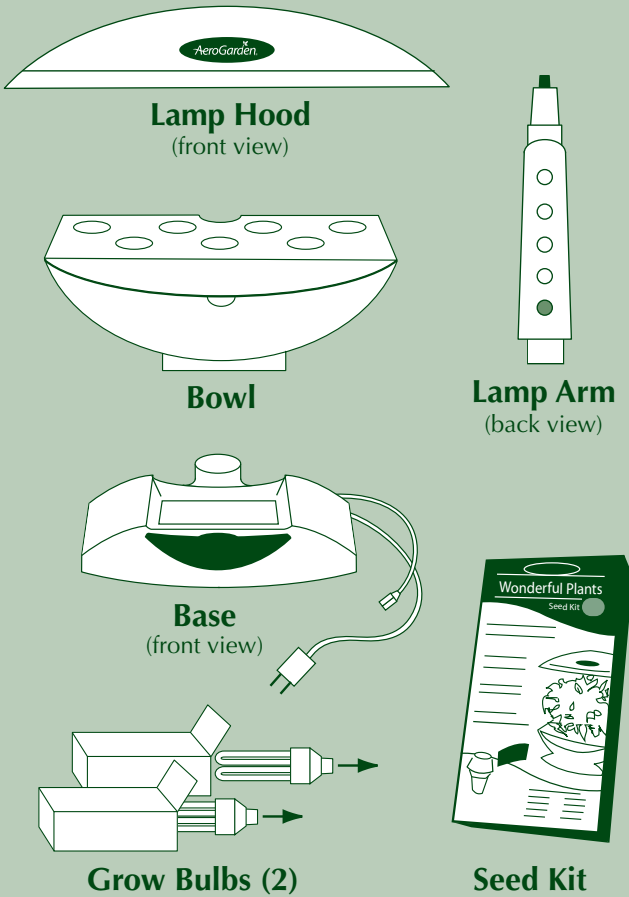

B Insert Lamp Arm into Base

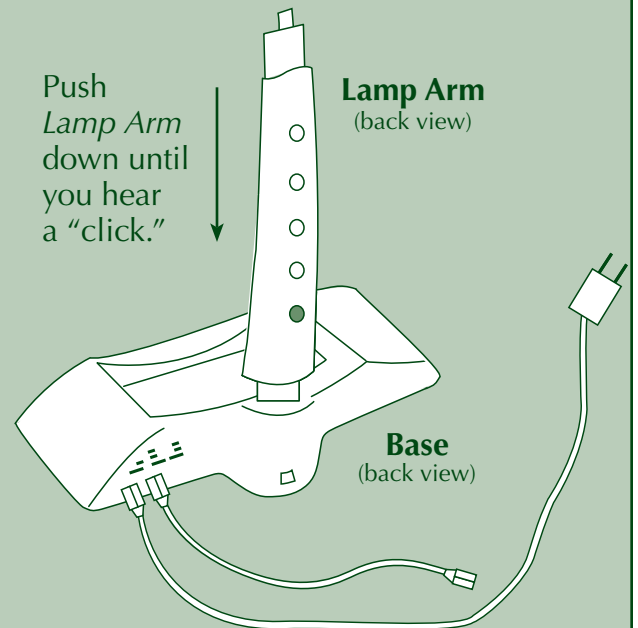

D Plug Lamp Cord into Lamp Hood

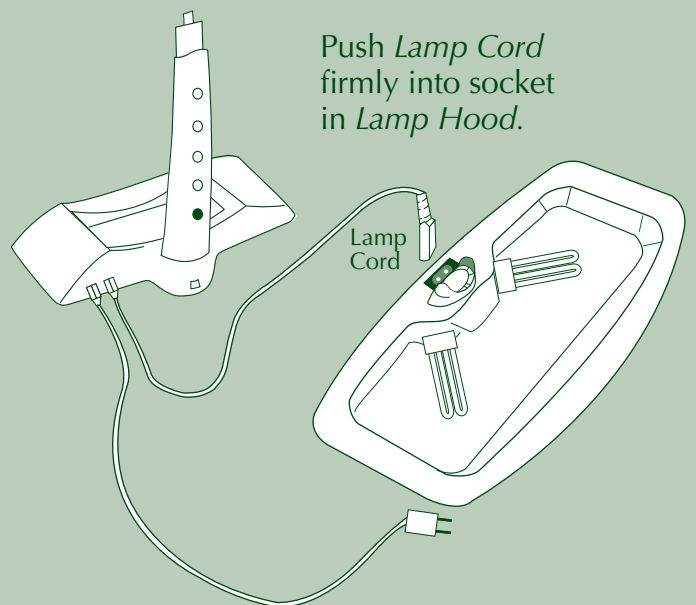

C Insert Grow Bulbs into Lamp Hood

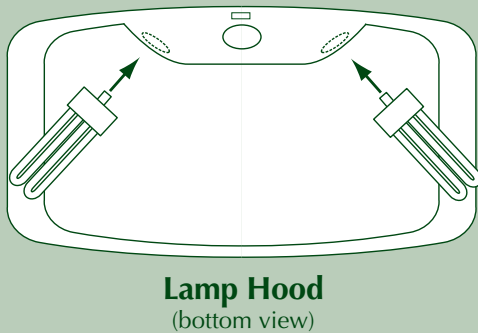

Push straight in.
DO NOT TWIST BULBS!

Remember to replace Grow Bulbs every 6 months.

1 Quick Start Assembly (continued)

E Place Lamp Hood on Lamp Arm

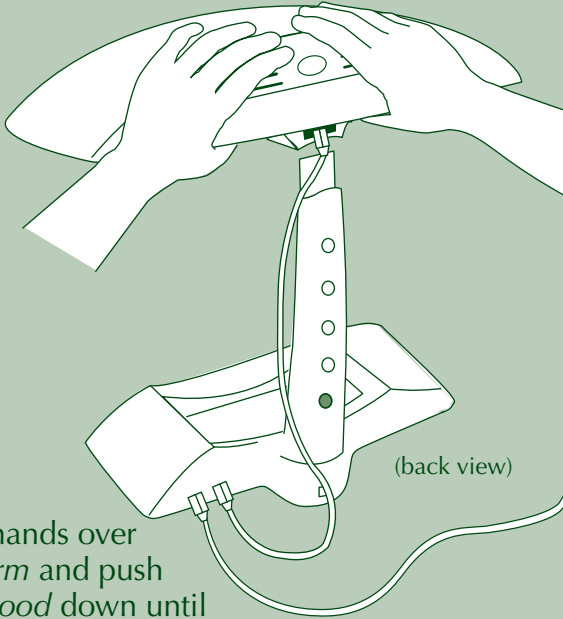

(back view)

Center hands over *Lamp Arm* and push *Lamp Hood* down until you hear a "click."

F Set Bowl into Base

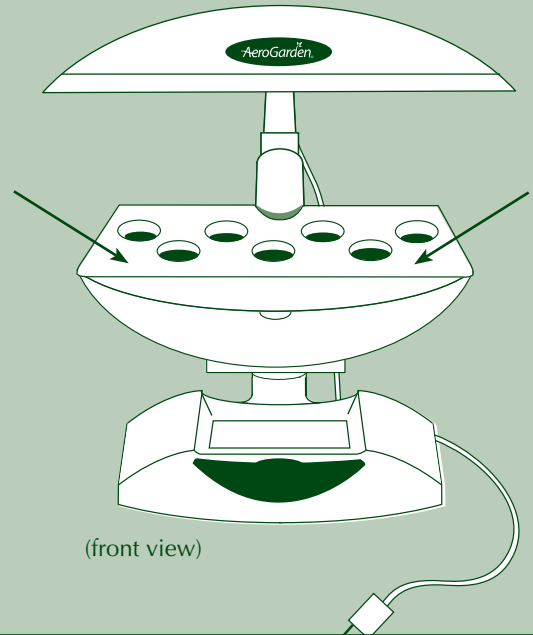

(front view)

Check to be sure that *Bowl* is securely in place.

G Moving Your AeroGarden

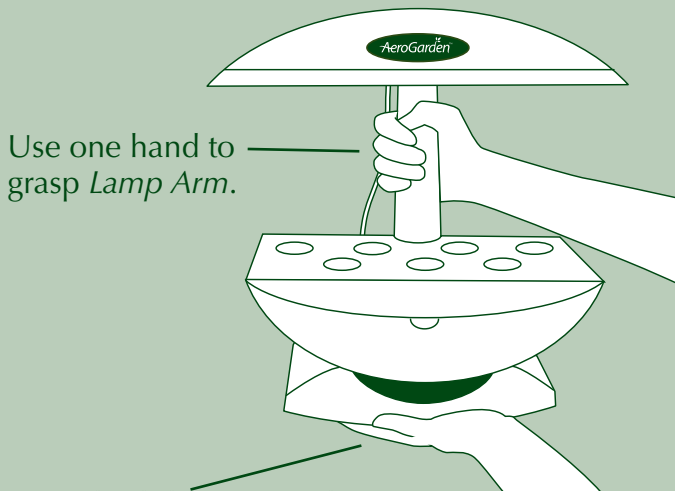

Use one hand to grasp *Lamp Arm*.

Gently slide AeroGarden toward the surface edge and place other hand under *Base*.

NEED ADDITIONAL HELP?
For supplies and information, visit...
www.aerogardensupport.com

H Place Your Garden

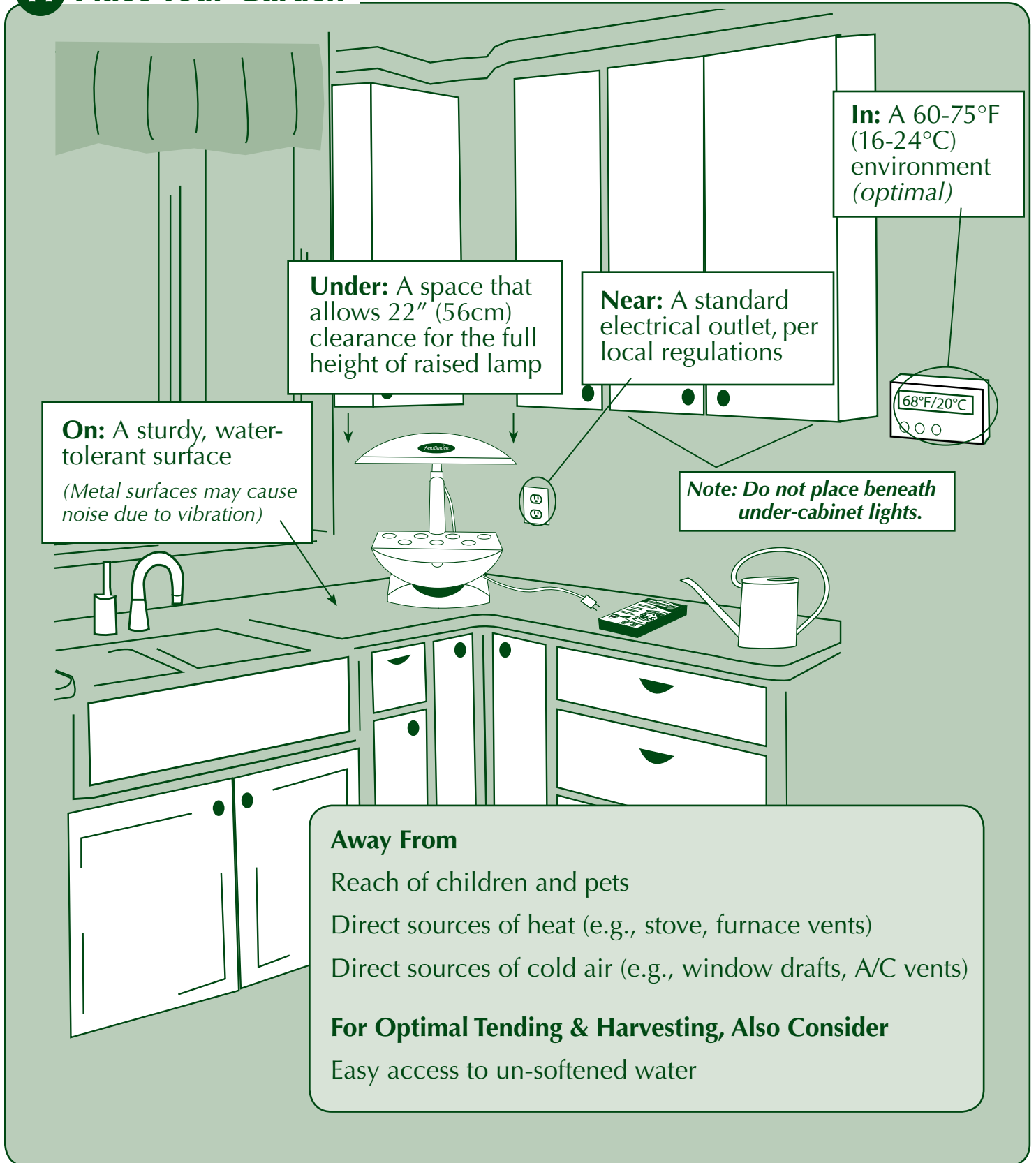

2 Planting Your Garden

A Add Water Using a Spouted Container

Use *room temperature* municipal tap, bottled or purified water. Do not use well or softened water.

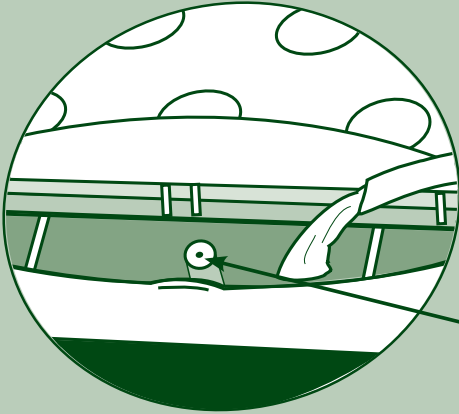

Fill to "*Fill To Here*"
(located inside the *Bowl*)

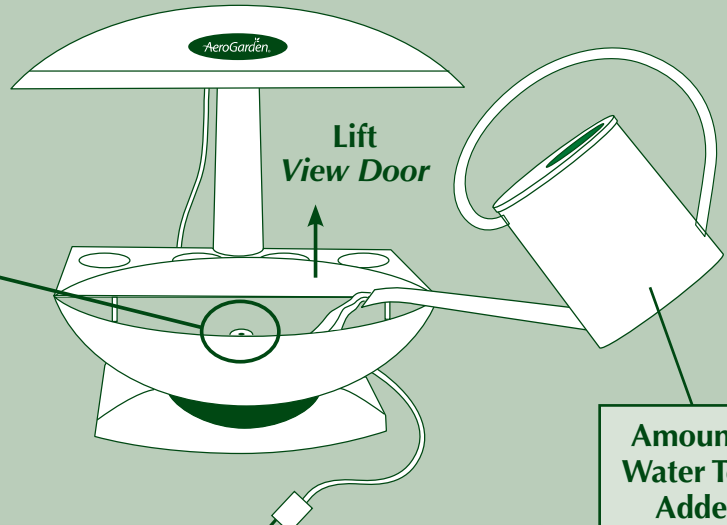

Amount of Water To Be Added:
3.5 quarts or...
3.2 liters

When additional water is needed, "Water Level Low" light on *Control Panel* will blink. Add water to raise level up to "*Fill To Here*" inside *Bowl*. It is okay to add water up to "*Fill To Here*" before "Water Level Low" light blinks.

B Plant Your Garden

Insert *Seed Pods* into *Grow Surface* openings.

Check to see that...

- *Seed Pods* are in the same position in *Grow Surface* as they were in *Seed Kit Tray*.
- *Seed Pod Labels* are facing forward.
- *Seed Pods* are pressed firmly in place.

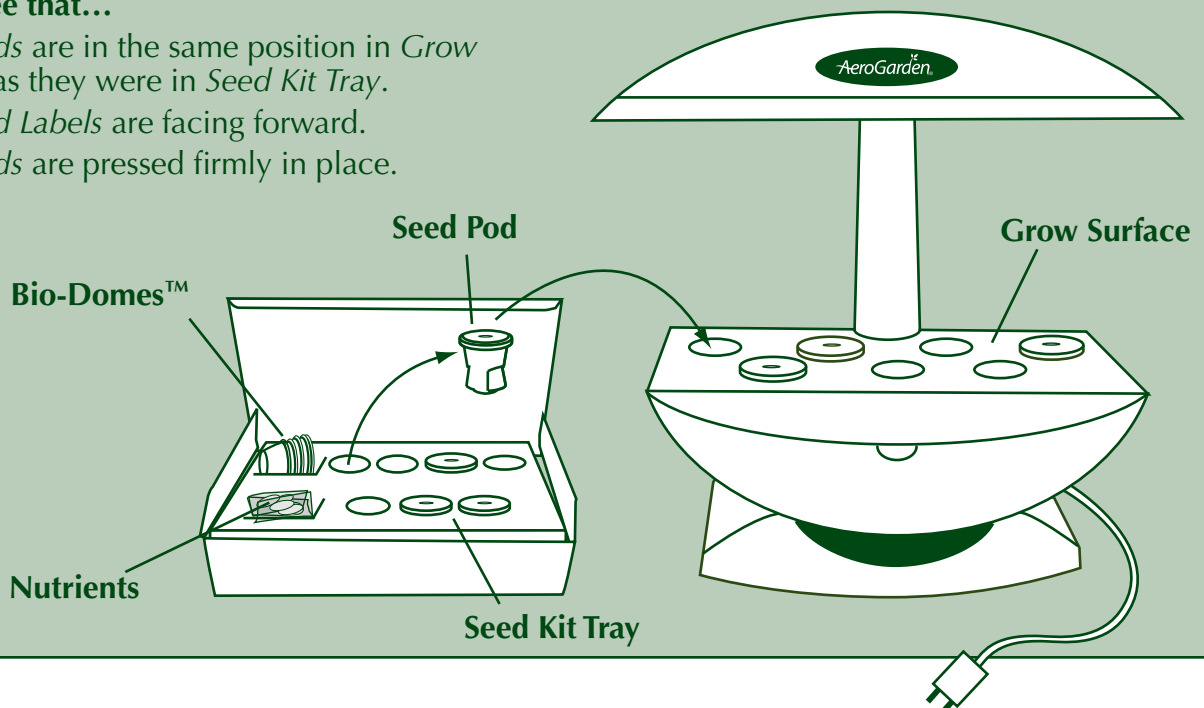

C Place Bio-Domes on Seed Pods

Place a *Bio-Dome* on each *Seed Pod*.

Press *Bio-Dome* down until its rim almost touches *Grow Surface*.

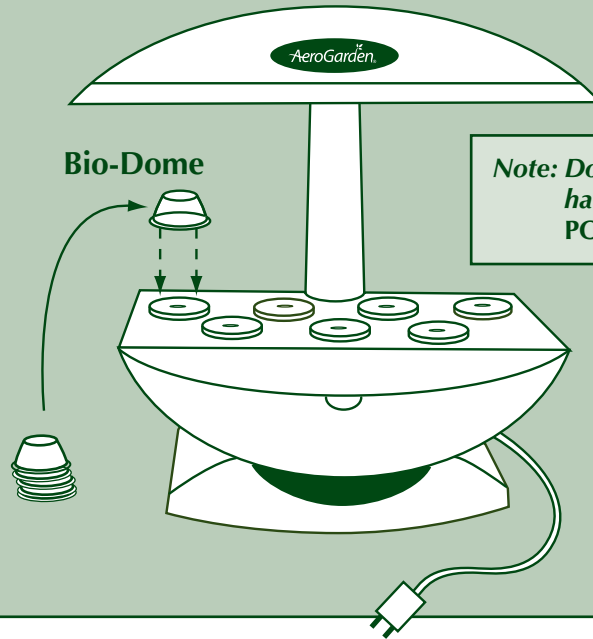

Note: Do not remove *Bio-Domes* until seeds have sprouted. NEVER REMOVE SEED POD LABELS.

D Add Starting Nutrient Tablets and Record Planting Date

Record Planting Date

Record the date you planted your AeroGarden on the front cover of the *Guide* that came with your *Seed/Plant Kit*.

Add 2 tablets from "Starting Nutrients" bag directly into *Bowl*.

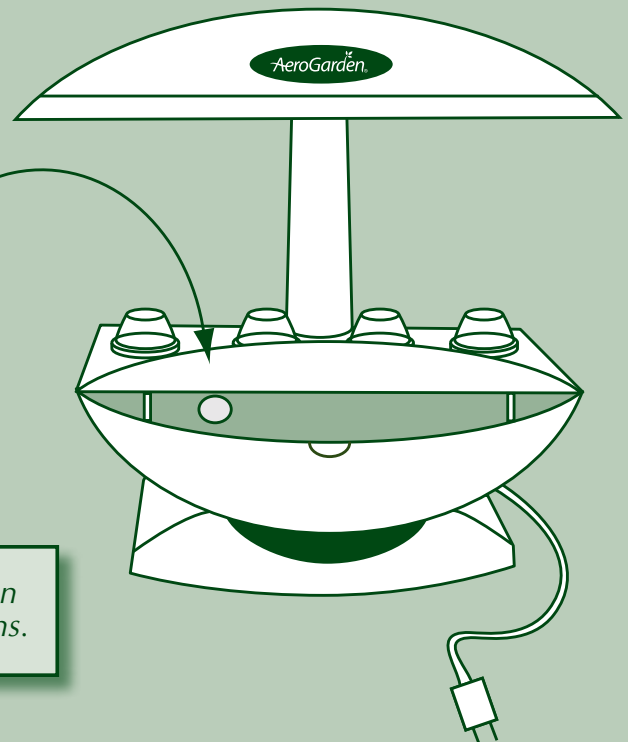

See "Add Nutrients" (*Feed Garden - Basic Feeding*) on page 10 of this guide for additional feeding instructions.

3 Starting Your Garden

A Plug Cord into Electrical Outlet

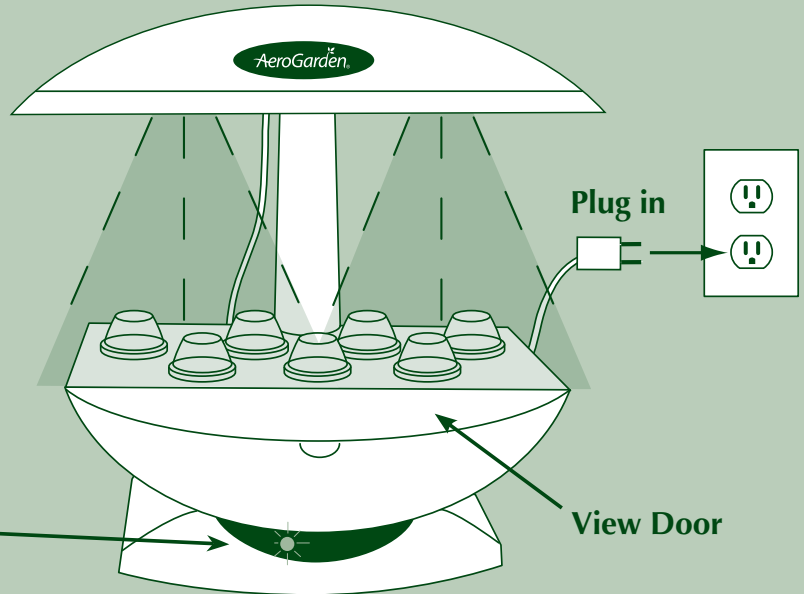

What will happen...

- 1** A green light on the *Smart Garden Control Panel* will light up.
- 2** *Grow Bulbs* will come on.
Look under Lamp Hood to see if both bulbs are lit.
If not, check to see if:
 - *Grow Bulbs* are properly inserted in *Lamp Hood* (page 2, step 1C).
 - *Lamp Cord* is plugged into *Lamp Hood* (page 2, step 1D).
 - You are getting power through the electrical outlet.
- 3** When Pump starts* it may make a gurgling noise for a moment.
Lift View Door. You should see water dripping from the bottom of Seed Pods into the Bowl.
If not, check to see if:
 - *Lamp Arm* is fully inserted into *Base* (page 2, step 1B).
 - *Bowl* is firmly seated on *Base* (page 3, step 1F).

*Pump may take up to twelve hours to start.

Note: You will hear water flowing until plant roots have grown to surface level of water (a few weeks). Keeping water level in Bowl up to "Fill To Here" will help reduce the sound of dripping water.

B Select Plant Type

Press the **SELECT** button until you reach the type of plant you are growing (Tomatoes/Peppers, Salad Greens, etc.).

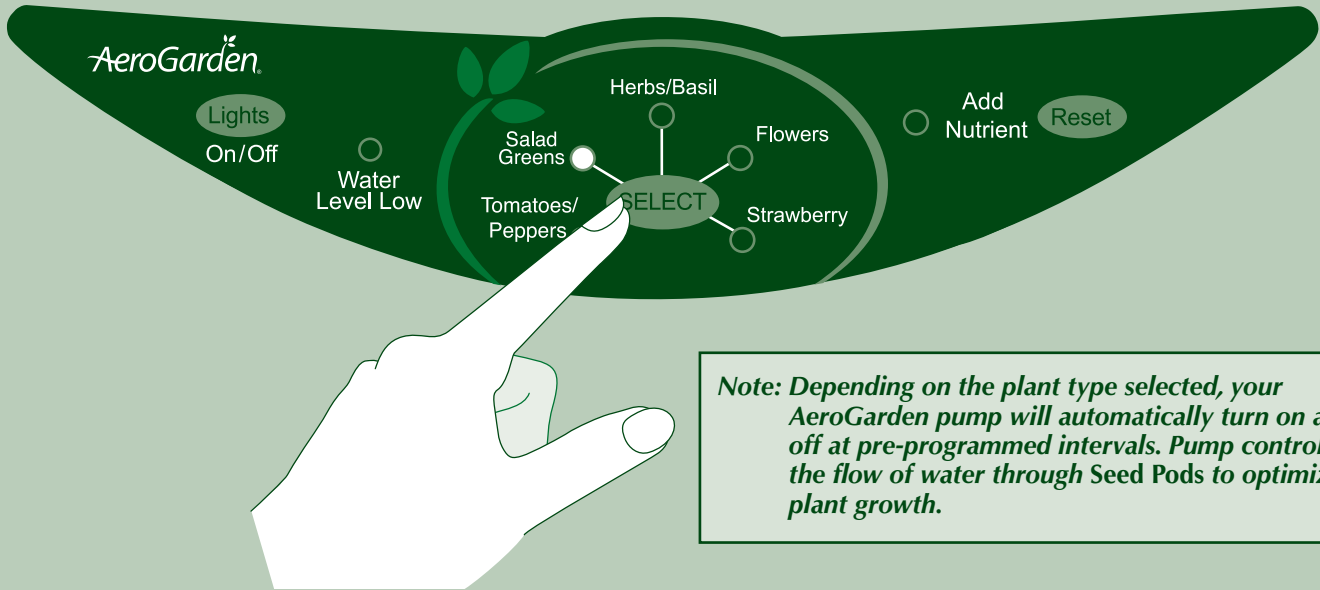

C Your Light Timer

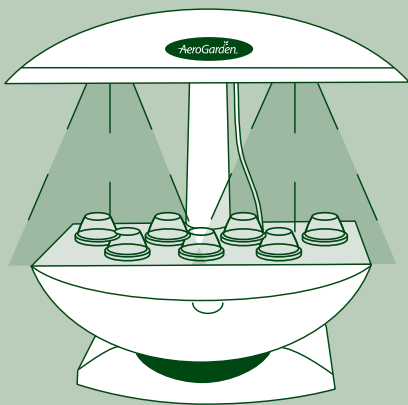

1

Your Light Timer is Set To Start Growing Your Plants...Starting Now!

2

If You Would Like to Change the Time of Day Your Lights Will Go Off...

See "Personalize Your Light Timer" on page 9.

- Your lights will stay on for about **16 hours** and will shut off for about **8 hours**.
- Your lights will come on every day at the time you plugged in your AeroGarden.

Personalize Your Light Timer (optional)

Your AeroGarden has lights and a built-in timer that automatically provide plants with the optimal amount of “sunlight” (about 16 hours) and “night” (about 8 hours), depending on the plant type selected in the previous section.

As long as plants get this amount of light, it does not matter when the lights are turned off.* Many people find it convenient to have the lights go on in the morning and off at night to match their own wake and sleep schedule.

**The exceptions to this are Flower, Tomato & Pepper plants. They require a daily dark period in order to produce flowers. If your plants will receive any room light during the day (natural or artificial), we recommend that you set your AeroGarden lights to be on during the day.*

5 Simple Steps...

In order to make this as simple as possible, you only need to set the time you want your AeroGarden

lights to go off (Off Time), and your built-in light timer automatically sets the On Time...nothing more for you to do.

Do the following to set the time you want your lights to go off:

- 1 Decide what time of day you want the lights to go OFF.
- 2 *AT THAT TIME* check that lights are on. If they are off, quickly press “Lights” button and immediately release. (Lights must be on in order to reset timer.)
- 3 With lights on, press and hold “Lights” button until the green light next to the plant type you selected starts blinking – about 5 seconds.
- 4 Release the button.
- 5 When blinking stops (about 9 seconds), the lights will go off. Your lights are now set to go off at this time every day.

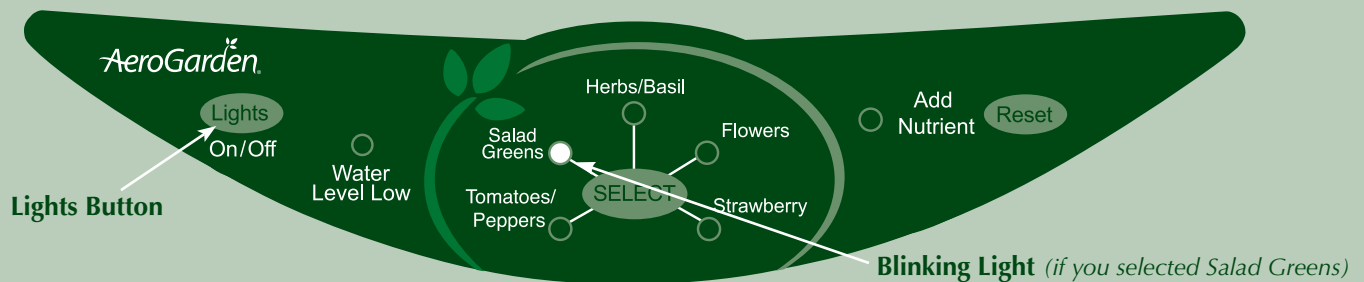

Now, each day, your AeroGarden lights will automatically

- Turn Off at the time you set using the above steps
- Remain off for about 8 hours
- Turn on for about 16 hours

You can reset your timer as often as you want.

If light from your AeroGarden is visible from your bedroom, you may want to set the lights to go off about the time you usually go to bed, so as not to disturb your sleep.

In case of power failure, your AeroGarden has a backup system that stores your light & nutrient timers and plant selection settings. When power is restored, your AeroGarden will go back to the Off-On cycle you have set.

Basic Reminders About Your AeroGarden

AeroGarden Classic *Control Panel* Features

- **Water Level Low**
When light blinks add water up to "Fill to Here."
- **Add Nutrients (Feed Garden - Basic Feeding)**
When "Add Nutrient" and "Water Level Low" lights start blinking (every 2 weeks), add 2 nutrient tablets* and fill the *Bowl* with water up to "Fill to Here." Press and release the "Reset" button to restart nutrient timer and turn off blinking lights.
**See Tending & Harvesting Guide for plant-specific nutrient information.*

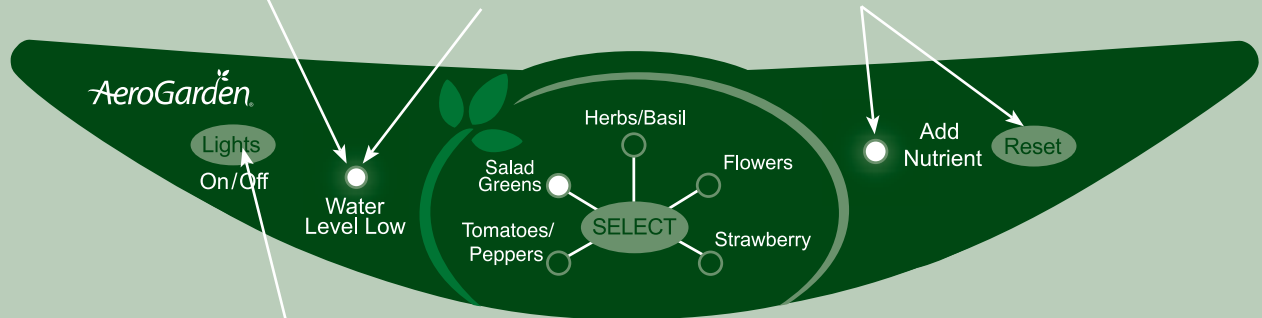

- **Lights On/Off**
Use to *occasionally* override built-in light timer. Once pushed, lights will stay off/on until the next time built-in light timer is set to go on/off. This will not affect the timing of your light cycle and *occasional* use of this feature will not harm your plants.

Remember: Grow Bulbs should be replaced every 6 months – order replacement bulbs at www.aerogardensupport.com or from your retailer.

- **Remove Bio-Domes**
When plants appear through the hole in *Seed Pod Labels*, remove *Bio-Domes* and discard or recycle.

NOTE: Never remove *Seed Pod Labels*.

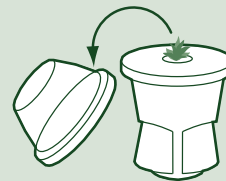

Basic Reminders About Your AeroGarden (continued)

Raise Lamp Hood (Lights)

As plants grow to **1-2" from lights**, raise *Lamp Arm* one *Locking Button* at a time. Be sure *Lamp Arm* is set on the lowest *Locking Button* when you start your AeroGarden.

1 Unplug AeroGarden.

2 Remove *Bowl* from *Base*.



3 Raise *Lamp Arm/Lamp Hood* by holding *Lamp Arm & Hood* with one hand, and pushing in *Locking Button* with the other.

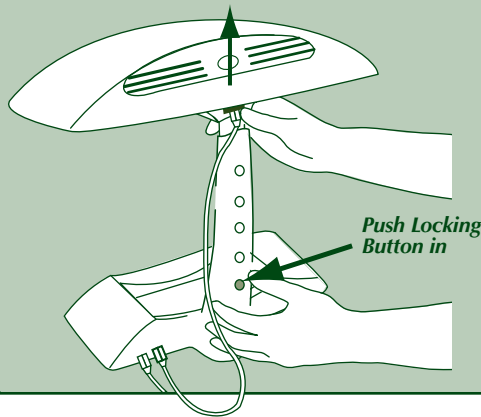

4 Replace *Bowl* on *Base*.

5 Plug in AeroGarden.



Replace Grow Bulbs

It is important to keep track of how long your *Grow Bulbs* have been in use and replace them every 6 months. After 6 months of use, the quality of light from the *Grow Bulbs* in your AeroGarden begins to degrade. This happens with all full-spectrum fluorescent bulbs, and is a critical issue when growing plants. In order for plants to be healthy and productive, they must receive the appropriate intensity and spectrum of light.

How To Replace *Grow Bulbs*...

- Unplug AeroGarden.
- Remove old *Grow Bulbs* and carefully discard*.

IMPORTANT: To avoid burning, be sure *Grow Bulbs* are cool before handling.

- Insert new *Grow Bulbs* into *Lamp Hood*.
- Plug in AeroGarden.

*Check with local recycling authorities for light bulb recycling availability in your area.

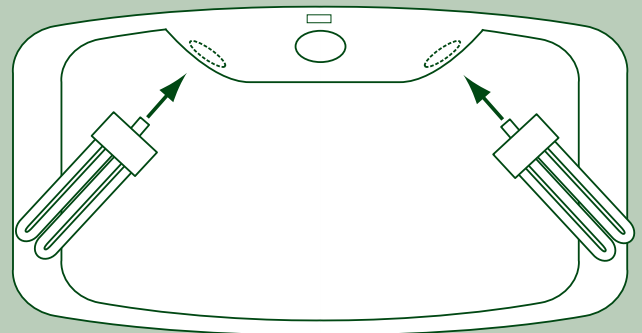

Order replacement bulbs at www.aerogardensupport.com or from your retailer.

Prepare For Your Next Garden

Cleaning and Storage Instructions for your AeroGarden

When your garden has completed its growing cycle...

1 Unplug AeroGarden.

2 Carefully remove *Bowl* and *Grow Surface* from the *Base* and bring to a sink.

Set *Base* and *Lamp Hood* aside.
NEVER SUBMERSE BASE AND CONTROL PANEL IN WATER.

3 Remove *Grow Surface* from *Bowl* and place on a counter near a sink.

4 Empty contents of *Bowl* in sink.

5 Remove *Seed Pods* and plants from *Grow Surface*.

- Pull *Seed Pods* out of *Grow Surface* openings.
- Throw away *Seed Pods* and plant debris (plant growth and roots). If you compost, plant debris can be composted.

6 Rinse and clean *Grow Surface*, *Pump Stand* and *Pump Filter**.

- Use a soft scrub brush to clean tangled roots from underside of *Grow Surface* and *Pump Stand*.
- Remove *Pump Filter* from *Pump Stand*. Gently scrub roots from *Pump Filter*.
- Place *Pump Filter* back into *Pump Stand*.

*After cleaning, there may still be a few roots in your *Grow Surface*, *Pump Stand* or *Pump Filter*. This will not affect the operation of your AeroGarden.*

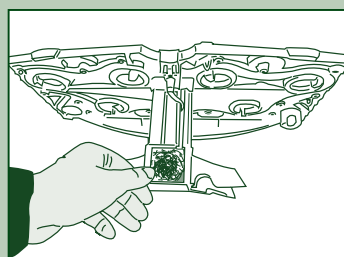
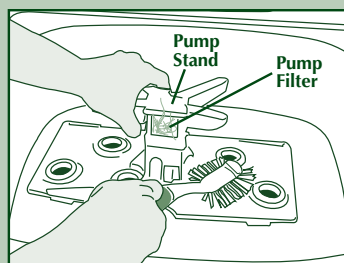
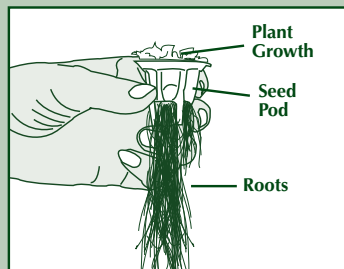
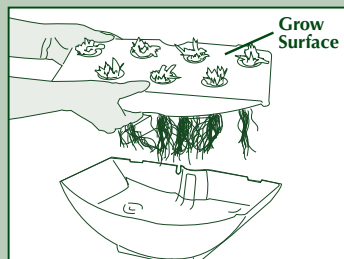
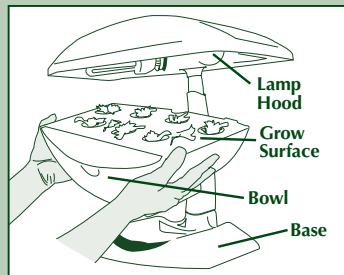

7 Sanitize AeroGarden.

- Fill *Bowl* $\frac{3}{4}$ full with water.
- Add $\frac{1}{4}$ cup (59ml) of chlorine bleach.
- Replace *Grow Surface* on *Bowl*, place *Bowl* on *Base* and plug in AeroGarden for 1-2 minutes. (*Select Salad Greens on Control Panel to be sure water is flowing.*)
- Unplug AeroGarden and empty bleach water from *Bowl*.

8 Rinse AeroGarden.

- Refill *Bowl* with tap water and replace on *Base*.
- Plug in and run AeroGarden for 1-2 minutes. (*Select Salad Greens again.*)
- Empty *Bowl* and repeat this step (step 8) one more time.

9 Towel dry the *Bowl* and *Grow Surface* before putting them back together and setting them back on the *Base*.

10 If your *Grow Bulbs* have been in use more than 6 months, they should be replaced at this time.

11 Your AeroGarden is now ready for replanting.

! • Use only water and mild soap when cleaning your AeroGarden (except when Sanitizing - Step 7). Do not use abrasive cleaners or run through the dishwasher.

* **IMPORTANT NOTE:** We recommend replacing the *Pump Filter* after growing two gardens. Order *Pump Filters* from www.aerogardensupport.com or from your retailer.

Prepare For Your Next Garden (continued)

Replanting Your AeroGarden

If this is the FIRST garden planted in your AeroGarden, you may DISREGARD these instructions.

If you have already grown a garden in your AeroGarden, please follow the instructions below to reset the nutrient timer:

Before planting a new garden, be sure to restart the nutrient timer.

- Press and hold “Reset” button until the red “Add Nutrient” light blinks 3 or 4 times (approximately 9 seconds).
- Release “Reset” button. “Add Nutrient” light will turn off.
- Your nutrient timer is now reset.
(In some cases you may see other lights blink as well. This is nothing to worry about.)

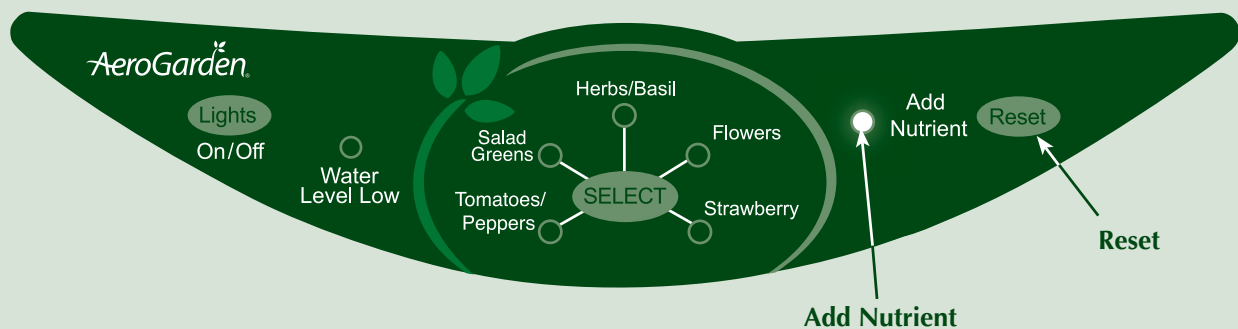

Remember to...

- Replace your *Grow Bulbs* after 6 months of use. *Grow Bulbs* can be ordered at www.aerogardensupport.com or from your retailer.
- Sanitize your AeroGarden *before* re-planting (see page 12).
- Set *Lamp Hood* to the lowest position when starting a new garden.

! Bundle cord when furnishing is not in use.

U.S. CAUTION – You are cautioned that any changes or modifications not expressly approved in this manual could void your authority to operate this equipment.

NOTE: This equipment has been tested and found to comply with the limits for a Class B digital device, pursuant to Part 15 of the FCC Rules. These limits are designed to provide reasonable protection against harmful interference in a residential installation. This equipment generates, uses, and can radiate radio frequency energy and, if not installed and used in accordance with the instructions, may cause harmful interference to radio communications. However, there is no guarantee that interference will not occur in a particular installation. If this equipment does cause harmful interference to radio or television reception, which can be determined by turning the equipment off and on, the user is encouraged to try to correct the interference by one or more of the following measures: Reorient or relocate the receiving antenna; Increase the separation between the equipment and receiver; Connect the equipment into an outlet on a circuit different from that to which the receiver is connected; or, Consult the dealer or an experienced radio/TV technician for help.

To reduce the risk of electric shock, this furnishing has a polarized plug (one blade is wider than the other). This plug will fit in a polarized outlet only one way. If the plug does not fit fully in the outlet, reverse the plug. If it still does not fit, contact a qualified electrician to install the proper outlet. Do not change the plug in any way.

CAUTION: TO PREVENT ELECTRIC SHOCK, MATCH WIDE BLADE OF PLUG TO WIDE SLOT, FULLY INSERT.

ATTENTION: POUR ÉVITER UN CHOC ÉLECTRIQUE, PRÉSENTER LA LAME LARGE À LA FENTE LARGE ET POUSSER JUSQU'AU FOND.

The logo for AeroGarden, featuring the brand name in a white, sans-serif font with a registered trademark symbol. A small green sprout with two leaves is positioned above the letter 'd' in 'Garden'.

© 2006-2008 AeroGrow International, Inc., Boulder, CO U.S.A. U.S. Patents Pending

5/7/08